

IDEM TONGUE INTERLOCK SAFETY SWITCHES KM

KM

203001A

KM M20 '2NC 1NO' - std actuator



- Robust die cast housing
- Slim fitting designed for where impact resistance is required
- Available with die cast or stainless steel head
- 8 Actuator entry positions- rotatable head
- IP67 ingress protection rating



Product description

Features

IDEM KM Interlock switches are designed to provide position interlock detection for medium to heavy duty moving guards

They have robust die-cast housings and are designed to fit to the leading edge of sliding, hinged or lift off machine guards. They provide a forced disconnect of the safety contacts at the withdrawal of the actuator and have an anti-tamper mechanism

The rotatable heads have dual actuator entry positions to give up to 8 different entry positions. For extra durability, Flexible Actuators and Stainless Steel head versions are available



Contact blocks are replaceable with optional explosion proof versions. High holding force versions are available for applications where vibration can be a nuisance

Functional specifications

- Positive Break Contacts to EN60947-5-1
- High Functional Safety to ISO13849-1
- 3 pole, 4 pole or Explosion Proof Contact Blocks
- Stainless Steel Head version available
- Connects to most Safety Relays to give up to PLe Cat.4
- Industry Standard Fitting: 40mm wide 118mm long 30mm fixing

Specifications

Actuator	Standard
Annual usage	8 cycles per hour/24 hours per day/365 days
Approvals	ISO 14119, EN60947-5-1, EN60204-1, ISO 13849-1, EN62061, UL 508
Atex approved	No
Central Material	Die cast metal
Conduit entry	M20
Contacts	2NC 1NO
Head material	Die cast metal
IP Class	IP67
Maximum approach / withdrawal speed	600
Mechanical reliability B10d	2.5 x 10 ⁶ operations at 100mA load
Mounting	4 x M5
MTTFd	356 years
Operating temperature	-25..80°C
PFHd	3.44 x 10 ⁻⁸
PL	e acc. ISO13849-1
Rated insulation voltage	500V ac
SIL	3 acc. EN62061
Thermal current (Ith)	5
Travel for positive opening	8
Withstand voltage	2500V ac

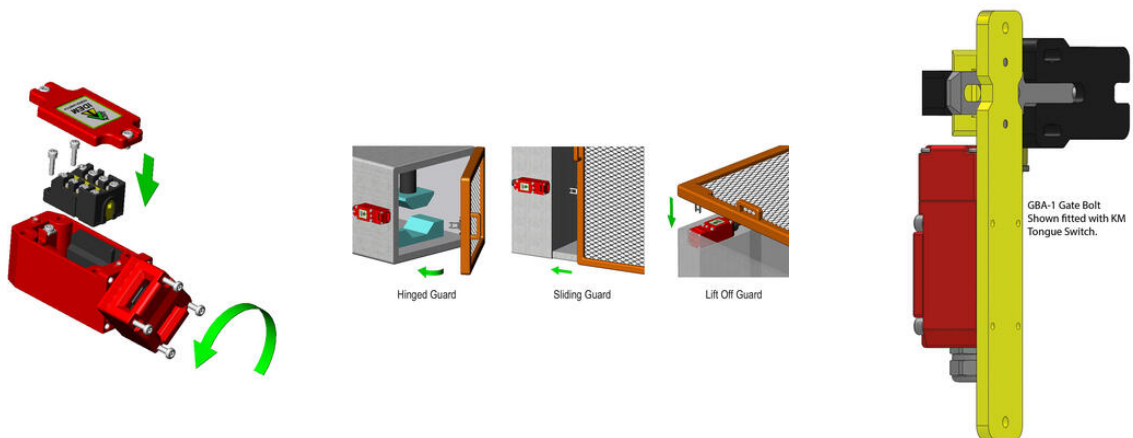

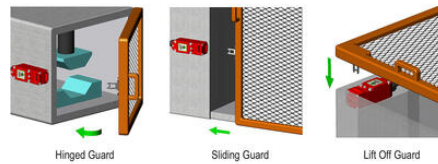
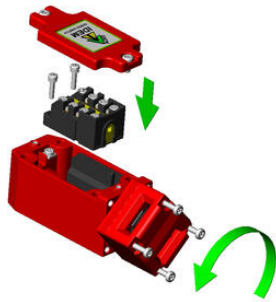
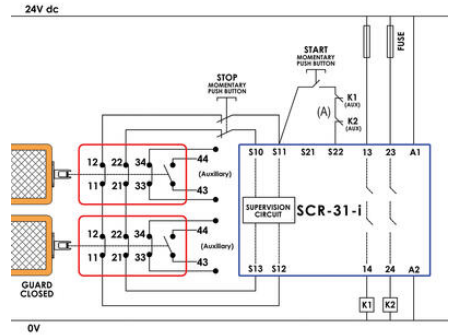
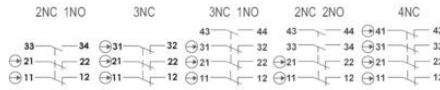
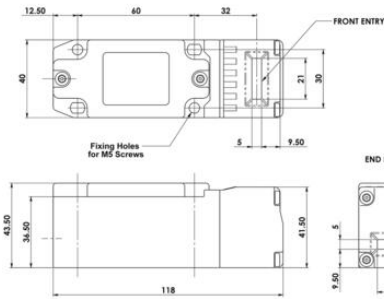
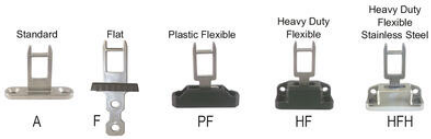

GBA-1 Gate Bolt
Shown fitted with KM
Tongue Switch.



